

**IRWIN®**



## WISE-GRIP®

The Vise-Grip® Locking Tool was invented in 1924 by a blacksmith in a small town of DeWitt, Nebraska. William Petersen was a Danish immigrant who invented the first locking pliers in his blacksmith shop, and began selling them from the back of his car to farmers and people in surrounding towns. He patented his new idea and called it VISE-GRIP®.

Since then, VISE-GRIP® has gained global brand recognition as the first choice for locking pliers. Innovation and quality are the core values of the VISE-GRIP® brand. With proven performance in every turn, these are the tools that tradespeople choose first – and pass on to the next generation.

The IRWIN® VISE-GRIP® family offers a full line of locking pliers, water pump pliers, cutting and VDE Pliers. IRWIN® VISE-GRIP® pliers and wrenches continue to set the standard for dependability, quality, and innovation today and tomorrow. Wherever there's a need for a quality tool, IRWIN® VISE-GRIP® is on the job.



## Record®

Originally established in 1898 in the South Yorkshire city of Sheffield in the UK, the Record Tools Factory was swiftly able to make a long lasting contribution to the worldwide reputation of the region for the manufacture of high quality steel and castings.

The Record® brand name was introduced in 1909 and by the 1920's the product range had expanded into vices, planes, clamps and pipe wrenches enabling the business to grow rapidly in the UK and many overseas markets.

Today, IRWIN® Record® continues excelling by sticking to the traditional values set by its founders, producing tools that are highly valued amongst professional users for quality and durability that remains strong today.



### LOCKING TOOLS



### PLIERS



### WRENCHES



# LOCKING PLIERS

### The Original

Since 1924™

IRWIN® VISE-GRIP® Original locking tools, with a classic guarded trigger release, are designed to provide maximum locking force.

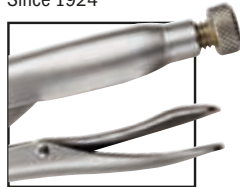

### Fast Release

IRWIN® VISE-GRIP® Fast Release locking pliers have a one-handed, triggerless release, so they're twice as easy to open as the traditional design. Plus, anti-pinch, non-slip ProTouch™ Grips provide comfort, control, and less hand fatigue.



SELF-ENERGISING LOWER JAW

UNIQUE CURVED JAW

PROTOUCH™ GRIPS

**10CR FAST RELEASE LOCKING PLIER - THE PERFECT GRIP FOR ANY JOB.**

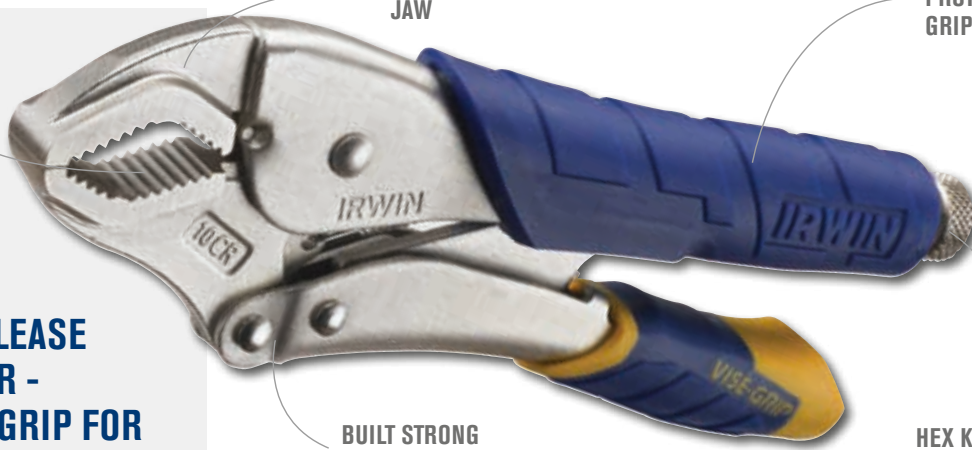

BUILT STRONG TO LAST LONG

T11T

HEX KEY ADJUSTING SCREW



**1. UNIQUE CURVED JAW**

Great for securely gripping and torquing multiple surface shapes, including round pipes, square or hex bolts and more. Perfect for any application that requires maximum torque

**2. SELF-ENERGISING LOWER JAW**

Jaw mechanism provides 3X more gripping power\*. Pivot allows jaw to align on workpiece for maximum grip without slipping or stripping

**3. PROTOUCH™ GRIPS**

Provides comfort, control and less hand fatigue

**4. 2X LONGER LIFE\***

High grade alloy steel is heat treated for maximum toughness and durability

**5. HEX KEY ADJUSTING SCREW**

Tightens to draw material closer together for tighter grip. Loosens to provide controlled release

**3X MORE GRIPPING POWER\***

**2X LONGER LIFE\***

**ProTouch™ GRIPS**

### CURVED JAW LOCKING PLIERS

Self-energising lower jaw provides three times more gripping power, with no slipping or stripping on any style nut or bolt head.

T10T



10508017



ITEM NO.	DESCRIPTION	CAPACITY	EAN	MASTER PACK	SHELF PACK	LP Ex VAT \$ / ITEM	RRP Inc VAT \$ / ITEM	DISC CODE	
<b>Fast Release</b>									
T10T	Fast Release - 5CR 5"/ 125mm	29mm	5706915081459	25	5	16.91	20.29	IR (HT)	
T13T	Fast Release - 7CR 7"/ 175mm	38mm	5706915081442	25	5	18.25	21.90		
T11T	Fast Release - 10CR 10"/ 250mm	48mm	5706915081435	25	5	20.97	25.16		
<b>The Original</b>									
10508019	Original - 5CR 5"/ 125mm	29mm	5706915080193	25	5	15.39	18.47		
10508018	Original - 7CR 7"/ 175mm	38mm	5706915080186	25	5	16.59	19.91		
10508017	Original - 10CR 10"/ 250mm	48mm	5706915080179	25	5	19.08	22.90		

\*vs. traditional locking pliers

# PLIERS & WRENCHES

## STRAIGHT JAW LOCKING PLIERS

Straight jaw provides maximum contact on flat, square or hex materials.

ITEM NO.	DESCRIPTION	CAPACITY	EAN	MASTER PACK	SHELF PACK	LP Ex VAT £ / ITEM	RRP Inc VAT £ / ITEM	DISC CODE	
<b>Fast Release</b>									
T03T	Fast Release - 7R 7"/ 175mm	38mm	5706915081800	25	5	18.25	21.90	IR (HT)	
T01T	Fast Release - 10R 10"/ 250mm	48mm	5706915081794	25	5	20.97	25.16		
<b>The Original</b>									
T0302EL4	Original - 7R 7"/ 175mm	38mm	0038548003016	25	5	16.59	19.91		
T0102EL4	Original - 10R 10"/ 250mm	48mm	0038548001067	25	5	19.08	22.90		



T01T



T0102EL4

## CURVED JAW LOCKING PLIERS WITH WIRE CUTTER

The curved jaw provides for a better fit around curved work shapes. Built-in wire cutter is great for a variety of applications and material shapes.

ITEM NO.	DESCRIPTION	CAPACITY	EAN	MASTER PACK	SHELF PACK	LP Ex VAT £ / ITEM	RRP Inc VAT £ / ITEM	DISC CODE
<b>Fast Release</b>								
T09T	Fast Release - 5WR 5"/ 125mm	29mm	5706915081428	25	5	16.91	20.29	IR (HT)
T07T	Fast Release - 7WR 7"/ 175mm	38mm	5706915081411	25	5	18.25	21.90	
T05T	Fast Release - 10WR 10"/ 250mm	48mm	5706915081404	25	5	20.97	25.16	
<b>The Original</b>								
T1002EL4	Original - 4WR 4"/ 100mm	25mm	0038548001098	25	5	14.20	17.04	
T0902EL4	Original - 5WR 5"/ 125mm	29mm	0038548009063	25	5	15.39	18.47	
T0702EL4	Original - 7WR 7"/ 175mm	38mm	0038548007038	25	5	16.59	19.91	
T0502EL4	Original - 10WR 10"/ 250mm	48mm	0038548000510	25	5	19.08	22.90	



T05T



T0902EL4

## LONG NOSE LOCKING PLIERS WITH WIRE CUTTER

Long, straight nose provides easy access in narrow, hard-to-reach places.

ITEM NO.	DESCRIPTION	CAPACITY	EAN	MASTER PACK	SHELF PACK	LP Ex VAT £ / ITEM	RRP Inc VAT £ / ITEM	DISC CODE	
<b>Fast Release</b>									
T14T	Fast Release - 6LN 6"/150mm	51mm	5706915081466	25	5	21.44	25.73	IR (HT)	
T15T	Fast Release - 9LN 9"/225mm	70mm	5706915081473	25	5	24.15	28.98		
<b>The Original</b>									
T1602EL4	Original - 4LN 4"/100mm	41mm	0038548001678	25	5	17.72	21.26		
T1402EL4	Original - 6LN 6"/150mm	51mm	0038548001432	25	5	19.49	23.39		
T1502EL4	Original - 9LN 9"/225mm	70mm	0038548001517	25	5	21.96	26.35		



T15T



T1502EL4

## LOCKING C-CLAMPS WITH REGULAR TIPS

Wide-opening jaw provides greater versatility in clamping a variety of shapes.

ITEM NO.	DESCRIPTION	CAPACITY	EAN	MASTER PACK	SHELF PACK	LP Ex VAT £ / ITEM	RRP Inc VAT £ / ITEM	DISC CODE	
<b>Fast Release</b>									
10507190	Fast Release - 6R 6"/150mm	54mm	5706915071900	25	5	20.46	24.55	IR (HT)	
10507189	Fast Release - 11R 11"/275mm	102mm	5706915071894	25	5	36.35	43.62		
<b>The Original</b>									
T17EL4	Original - 6R 6"/150mm	54mm	0038548001715	25	5	18.60	22.32		
T19EL4	Original - 11R 11"/275mm	102mm	0038548001913	25	5	33.05	39.66		
T18R	Original - 18R - 18"/455mm	203mm	0038548000213	-	5	47.49	56.99		
T24R	Original - 24R - 24"/605mm	254mm	0038548002750	-	5	59.12	70.94		



10507189



T19EL4

## LOCKING C-CLAMPS WITH DEEP THROAT

The large C-Clamp with greater throat capacity makes this a highly versatility versatile tool in the clamping of wider work-pieces.

ITEM NO.	DESCRIPTION	CAPACITY	EAN	MASTER PACK	SHELF PACK	LP Ex VAT £ / ITEM	RRP Inc VAT £ / ITEM	DISC CODE
<b>The Original</b>								
T18DR	Original - 18DR Locking Clamp Deep Throat 18"/455mm	190mm	0038548002118	-	5	57.92	69.50	IR (HT)



T18DR



### LOCKING C-CLAMPS WITH SWIVEL PADS

The swivelling pads and greater throat depth allow this clamp to hold irregular shapes and tapered work pieces.



T20EL4

ITEM NO.	DESCRIPTION	CAPACITY	EAN	MASTER PACK	SHELF PACK	LP Ex VAT £ / ITEM	RRP Inc VAT £ / ITEM	VAT	DISC CODE
T16SEL4	Original - 4SP Locking C-Clamp 4"/100mm	41mm	0038548001661	25	5	18.99	22.79		IR (HT)
T18EL4	Original - 6SP Locking C-Clamp 6"/150mm	54mm	0038548001845	25	5	21.85	26.22		
T9SP	Original - 9SP Locking C-Clamp 9"/225mm	114mm	0038548003108	25	5	31.15	37.38		
T20EL4	Original - 11SP Locking C-Clamp 11"/275mm	102mm	0038548002019	25	5	35.62	42.74		
T18SP	Original - 18SP Locking C-Clamp 18"/455mm	203mm	0038548000220	-	5	48.90	58.68		
T24SP	Original - 24SP Locking C-Clamp 24"/605mm	254mm	0038548000282	-	5	63.62	76.34		

### LOCKING WRENCHES

The heavy-duty jaws lock onto three sides of hex fasteners and won't slip or mark workpieces.



4

ITEM NO.	DESCRIPTION	CAPACITY	EAN	MASTER PACK	SHELF PACK	LP Ex VAT £ / ITEM	RRP Inc VAT £ / ITEM	VAT	DISC CODE
8	Original - 4LW Locking Wrench 4"/100mm	7-14mm	0038548002415	25	5	19.43	23.32		IR (HT)
4	Original - 7LW Locking Wrench 7"/175mm	11-19mm	0038548000046	25	5	22.13	26.56		
2	Original - 10LW Locking Wrench 10"/250mm	16-28mm	0038548000022	25	5	24.58	29.50		

### LARGE JAW LOCKING PLIERS

The heavy-duty jaws grip all shapes; ideal for plumbers, mechanics, welders and large jobs.



12L3

ITEM NO.	DESCRIPTION	CAPACITY	EAN	MASTER PACK	SHELF PACK	LP Ex VAT £ / ITEM	RRP Inc VAT £ / ITEM	VAT	DISC CODE
12L3	Original - 12LC Large Jaw Locking Plier 12"/300mm	79mm	0038548012018	25	5	33.51	40.21		IR (HT)

### LOCKING SHEET METAL TOOL

The sheet metal tool makes bending, forming and crimping sheet metal easier.



23

ITEM NO.	DESCRIPTION	CAPACITY	EAN	MASTER PACK	SHELF PACK	LP Ex VAT £ / ITEM	RRP Inc VAT £ / ITEM	VAT	DISC CODE
23	Original - 8R Locking Sheet Metal Tool 8"/200mm	78mm	0038548000237	25	5	29.33	35.20		IR (HT)

### LOCKING PINCH OFF TOOL

The pinch-off tool provides a temporary seal when applied to tubing, leaving both hands free for other work.



29

ITEM NO.	DESCRIPTION	CAPACITY	EAN	MASTER PACK	SHELF PACK	LP Ex VAT £ / ITEM	RRP Inc VAT £ / ITEM	VAT	DISC CODE
29	Original - 7RR Locking Pinch-Off Tool 7"/175mm	6mm	0038548000299	25	5	23.98	28.78		IR (HT)

### LOCKING PANEL CLAMP

The specially designed jaw provides quick clamping and alignment of automotive body panels.

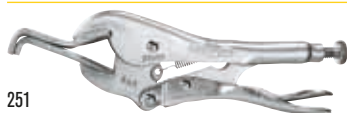

251

ITEM NO.	DESCRIPTION	CAPACITY	EAN	MASTER PACK	SHELF PACK	LP Ex VAT £ / ITEM	RRP Inc VAT £ / ITEM	VAT	DISC CODE
251	Original - 9AC Locking Panel Clamp 9"/225mm	70mm	0038548002514	25	5	33.90	40.68		IR (HT)

### LOCKING WELDING CLAMP

The U-shape jaw provides enhanced visibility of the weld area and access to the weld space, allowing for more accurate alignment of both round and square shape tubing during welding.



25ZR

ITEM NO.	DESCRIPTION	CAPACITY	EAN	MASTER PACK	SHELF PACK	LP Ex VAT £ / ITEM	RRP Inc VAT £ / ITEM	VAT	DISC CODE
25ZR	Original - 9R Locking Welding Clamp 9"/225 mm	70 mm	0038548000251	25	5	34.92	41.90		IR (HT)

# PLIERS & WRENCHES

## LOCKING CHAIN CLAMP

The chain holds and locks any shape or size up to 18"/455mm. Extension chains are available to extend to any length required.

ITEM NO.	DESCRIPTION	EAN	MASTER PACK	SHELF PACK	LP Ex VAT £ / ITEM	RRP Inc VAT £ / ITEM	DISC CODE
27ZR	Original - 20R Locking Chain Clamp 9"/225mm	0038548000275	10	5	36.19	43.43	IR (HT)



27ZR

## LOCKING PLIERS SPARE PARTS

ITEM NO.	DESCRIPTION	EAN	MASTER PACK	SHELF PACK	LP Ex VAT £ / ITEM	RRP Inc VAT £ / ITEM	DISC CODE
2071910	Adjusting Screw 5 Pc. - 10R, 10WR, 10CR, 20R, 12LC, 11R, 11SP, 18R, 18SP, 24R, 24SP, & 10LW	0038548095455	100	5	1.23	1.48	IR (HT)
4092	Replacement spring 5pc - 4WR, 4LN, 4SP, 4LW	0038548040929	100	5	1.23	1.48	
4935309	Replacement spring 5pc - 18R, 18SP, 24R, 24SP (box and packs marked 40-34)	0038548040349	100	5	1.23	1.48	
4008	Replacement spring 5pc - 10R, 10WR, 10CR, 11R, 11SP, 20R, 12LC, 10LW	0038548040080	100	5	1.23	1.48	
4022ZR	Replacement spring 5pc - 7R, 7WR, 7CR, 9LN, 8R, RR, 7LW	0038548040226	100	5	1.23	1.48	
4052ZR	Replacement spring 5pc - 5WR, 6LN, 6R, 6SP	0038548040523	100	5	1.23	1.48	4008



## LOCKING PLIERS SETS



T77T



T214T



T76KBT



10508020



T71













TVG73









ITEM NO.	DESCRIPTION	EAN	MASTER PACK	SHELF PACK	LP Ex VAT £ / ITEM	RRP Inc VAT £ / ITEM	DISC CODE
T77T	2 pc. Fast Release - (10WR, 6LN)	5706915081480	25	5	40.27	48.32	IR (HT)
T214T	2 pc. Fast Release - (10WR, 7WR)	5706915081497	25	5	37.28	44.74	
T76KBT	3 pc. Fast Release - (10WR, 9LN, 7R) in kitbag	5706915081503	25	5	63.37	76.04	
TVG73	3 pc. Original - (10WR 6LN 5WR) in kitbag	0038548000732	25	5	53.94	64.73	
10508020	3 pc. Original - (5CR, 7CR, 10CR) in storage tray	5706915080209	25	5	51.03	61.24	
T71	4 pc. Original - (10CR, 7R, 6LN, 5WR), in kitbag	0038548000718	-	5	70.52	84.62	



### LOCKING PLIER RANGE OVERVIEW

IMAGE	ITEM NO.	DESCRIPTION	SIZES	JAW CAPACITY	DESCRIPTION	RECOMMENDED APPLICATIONS		
	T10T	5CR 5"/125mm	5" / 125mm	1-1/8" / 29 mm	<b>CURVED JAW LOCKING PLIERS</b> Great for securely gripping and torquing multiple surface shapes, including round pipes, square or hex bolts, and more. Perfect for any application that requires maximum torque.	<b>Gripping Torque Rusted/Broken Screws</b>		
	T13T	7CR 7"/175mm	7" / 175mm	1-1/2" / 38 mm				
	T11T	10CR 10"/250mm	10" / 250mm	1-7/8" / 48 mm				
	T0508019	5CR 5"/125mm	5" / 125mm	1-1/8" / 29 mm				
	T0508018	7CR 7"/175mm	7" / 175mm	1-1/2" / 38 mm				
	T0508017	10CR 10"/250mm	10" / 250mm	1-7/8" / 48 mm				
	T03T	7R 7"/175mm	7" / 175mm	1-1/2" / 38 mm			<b>STRAIGHT JAW LOCKING PLIERS</b> The straight jaw pliers with heavy-duty jaws allow for maximum contact on all work shapes flat or square. It is very popular in welding and other metal work. Use for safer grinding or as a portable vice. The solid steel head makes this tool twice as strong as all other locking pliers.	<b>Holding Welding Clamping</b>
	T01T	10R 10"/250mm	10" / 250mm	1-7/8" / 48 mm				
	T0302EL4	7R 7"/175mm	7" / 175mm	1-1/2" / 38 mm				
	T0102EL4	10R 10"/250mm	10" / 250mm	1-7/8" / 48 mm				
	T09T	5WR 5"/125mm	5" / 125mm	1-1/8" / 29 mm	<b>CURVED JAW LOCKING PLIERS WITH WIRE CUTTER</b> The curved jaw pliers provide for a better fit around curved work shapes. Curved jaw with built-in wire cutter great for a variety of applications and material shapes.	<b>Wire Cutting Pulling, Prying Gripping</b>		
	T07T	7WR 7"/175mm	7" / 175mm	1-1/2" / 38 mm				
	T05T	10WR 10"/250mm	10" / 250mm	1-7/8" / 48 mm				
	T11002EL4	4WR 4"/100mm	4" / 100mm	1" / 25 mm				
	T0902EL4	5WR 5"/125mm	5" / 125mm	1-1/8" / 29 mm				
	T0702EL4	7WR 7"/175mm	7" / 175mm	1-1/2" / 38 mm				
	T0502EL4	10WR 10"/250mm	10" / 250mm	1-7/8" / 48 mm				
	T14T	6LN 6"/150mm	6" / 150mm	2" / 51 mm			<b>LONG NOSE LOCKING PLIERS WITH WIRE CUTTER</b> The long tapered nose plier is ideal for delicate work, hobbies, tight spaces, electronics and clamping of small parts. The long nose plier features a built in wire cutter which is helpful in tight spaces.	<b>Reaching Bending Pinching</b>
	T15T	9LN 9"/225mm	9" / 225mm	2-3/4" / 70 mm				
	T11602EL4	4LN 4"/100mm	4" / 100mm	1-5/8" / 41 mm				
	T11402EL4	6LN 6"/150mm	6" / 150mm	2" / 51 mm				
	T11502EL4	9LN 9"/225mm	9" / 225mm	2-3/4" / 70 mm				
	T0507190	6R 6"/150mm	6" / 150mm	2-1/8" / 54 mm	<b>LOCKING C-CLAMPS WITH REGULAR TIPS</b> The wide-opening jaws provide greater versatility in clamping projects than otherwise available with old fashioned clamps. The C-clamps with regular tips are very popular in welding, auto-body repair and other metal work. The fast release option allows users to move the clamps quickly with one hand while continuing to work with the other.	<b>Fabricating Welding Construction</b>		
	T0507189	11R 11"/275mm	11" / 275mm	4" / 102 mm				
	T17EL4	6R 6"/150mm	6" / 150mm	2-1/8" / 54 mm				
	T19EL4	11R 11"/275mm	11" / 275mm	4" / 102 mm				
	T18R	18R 18"/455mm	18" / 455mm	8" / 203 mm				
	T24R	24R 24"/605mm	24" / 254mm	10" / 254 mm				

# PLIERS & WRENCHES

IMAGE	ITEM NO.	DESCRIPTION	SIZES	JAW CAPACITY	DESCRIPTION	RECOMMENDED APPLICATIONS
	T165EL4 T18EL4 T9SP T20EL4 T18SP T24SP	4SP 4" / 100mm 6SP 6" / 150mm 9SP 9" / 225mm 11SP 11" / 275mm 18SP 18" / 455mm 24SP 24" / 605mm	4" / 100mm 6" / 150mm 9" / 225mm 11" / 275mm 18" / 455mm 24" / 254mm	1-5/8" / 41 mm 2-1/8" / 54 mm 4-1/2" / 114 mm 4" / 102 mm 8" / 203 mm 10" / 254 mm	<b>LOCKING C-CLAMPS WITH SWIVEL PADS</b>  The wide-opening jaws with swivel pads hold tapered work, awkward fabricating jobs and delicate projects. The C-Clamps with swivel pads are very popular in auto-body repair and other work on delicate or odd shaped surfaces.	<b>Holding Delicate Seams</b>
	T18DR	18DR 18" / 455mm	18" / 455mm	7-1/2" / 190 mm	<b>LOCKING C-CLAMPS - DEEP THROAT</b>  These clamps have extra throat width and depth for greater clamping reach. These features allow for many clamping applications in welding, automotive and steel framing.	<b>Fabricating Welding Construction</b>
	23	8R 8" / 200mm	8" / 200mm	3-1/8" / 78 mm	<b>LOCKING SHEET METAL TOOL</b>  The Locking Sheet Metal tool locks on to work with a powerful grip. The tool makes all kinds of bending, forming and crimping jobs easier and faster.	<b>Bending Crimping Forming</b>
	25ZR	9R 8" / 225mm	9" / 225mm	2-3/4" / 70 mm	<b>LOCKING WELDING CLAMP</b>  The Locking Welding Clamp has deep-throated and U-shaped jaws for visibility and working space. It holds work in proper alignment and is ideal for sheet metal work on automobiles.	<b>Welding Holding</b>
	27ZR	20R 9" / 225mm	9" / 225mm	18" / 455 mm	<b>LOCKING CHAIN CLAMP</b>  The Locking Chain Clamp holds and locks around any shape or any size of object and adjusts quickly for ratchet action in either direction. Extension chain is available.	<b>Holding</b>
	29	RR 7" / 175mm	7" / 175mm	1/4" / 6 mm	<b>LOCKING PINCH-OFF TOOL</b>  The Locking Pinch-Off tool with round jaws pinches and locks on tubing instantly without damaging the tubing. It is perfect to use for plumbing work, as it stops flow from untidy tubes. Very popular in the refrigeration market.	<b>Holding</b>
	251	9AC Locking Panel Clamp	9" / 225mm	2-3/4" / 70 mm	<b>LOCKING PANEL CLAMP</b>  The jaws for the Locking Panel Clamp are designed to move in a straight line motion which allows the handle to be out of the way. Auto-body panels can be clamped in place and the door shut to check for gaps before final welding.	<b>Clamping Welding</b>
	8 4 2	4LW 4" / 100mm 7LW 7" / 175mm 10LW 10" / 250mm	4" / 100mm 7" / 175mm 10" / 250mm	7 mm - 14 mm 11 mm - 19 mm 16 mm - 28 mm	<b>LOCKING WRENCH</b>  The jaws of the Locking Wrench lock on three sides of a bolt and will not slip or mark. The Locking Wrench is adjustable to over 16 wrench sizes and features a built-in wire cutter.	<b>Pulling Tightening</b>
	12L3	12LC 12" / 300mm	12" / 300mm	3-1/8" / 79 mm	<b>LARGE JAW LOCKING PLIER</b>  The large jaws and clamping ability make this tool ideal for plumbers, mechanics, welders and others who work with large objects. Also, its convenient size makes it easier to use than bulkier tools, such as pipe wrenches.	<b>Holding Clamping</b>





**IRWIN**<sup>®</sup>

**WISE-GRIP**<sup>®</sup>



## GROOVELOCK WATER PUMP PLIERS WITH PROTOUCH™ GRIP

ALL-PURPOSE JAW

PRESS-N-SLIDE BUTTON

ANTI-PINCH NON-SLIP PROTOUCH GRIPS



MULTI-GROOVE RATCHETING SYSTEM

10507627

### WATER PUMP PLIERS

GrooveLock Pliers are designed with twice the number of groove positions as traditional groove joint pliers to deliver optimal hand and jaw positioning - providing a superior grip. The specially engineered, all-purpose jaw grips round, hex, square and flat surfaces for incredible versatility.



- 1. ALL-PURPOSE JAW**  
Grips onto flat, round, hex & square work pieces to provide tremendous bite
- 2. PRESS-N-SLIDE BUTTON**  
Adjusts jaws 2X faster than traditional groove joint pliers
- 3. MULTI-GROOVE RATCHETING SYSTEM**  
Has twice the groove positions than other groove joint pliers, for precise positioning on any type of work surface
- 4. ANTI-PINCH NON-SLIP PROTOUCH GRIPS**  
Provide comfort, control and less hand fatigue

**2X FASTER\***  
\*vs traditional Groove Joint pliers

**ProTouch™**  
GRIPS

**GrooveLock**  
Pliers

ITEM NO.	DESCRIPTION	JAW CAPACITY	EAN	MASTER PACK	SHELF PACK	LP Ex VAT £ / ITEM	RRP Inc VAT £ / ITEM	DISC CODE
10507626	GV6 GrooveLock PTG 6"/150mm	29mm	5706915076264	25	5	19.54	23.45	IR (HT)
10507627	GV8 GrooveLock PTG 8"/200mm	45mm	5706915076271	25	5	20.92	25.10	
10507628	GV10 GrooveLock PTG 10"/250mm	57mm	5706915076288	25	5	24.40	29.28	
4935097	GV10S GrooveLock PTG 10"/250mm Smooth Jaw	57mm	0038548108629	25	5	24.40	29.28	
10507629	GV12 GrooveLock PTG 12"/300mm	70mm	5706915076295	20	5	30.25	36.30	
2078116	GV16 GrooveLock TG 16"/400mm	114mm	0038548088099	10	2	55.54	66.65	
2078120	GV16 GrooveLock TG 20"/510mm	152mm	0038548088105	5	1	76.87	92.24	



10507628



4935097

### GROOVELOCK WATER PUMP PLIERS WITH THIN GRIP

ITEM NO.	DESCRIPTION	JAW CAPACITY	EAN	MASTER PACK	SHELF PACK	LP Ex VAT £ / ITEM	RRP Inc VAT £ / ITEM	DISC CODE
10507630	GV6 GrooveLock TG 6"/150mm	29mm	5706915076301	25	5	19.54	23.45	IR (HT)
10507631	GV8 GrooveLock TG 8"/200mm	45mm	5706915076318	25	5	20.92	25.10	
10507632	GV10 GrooveLock TG 10"/250mm	57mm	5706915076325	20	5	24.40	29.28	
10507633	GV12 GrooveLock TG 12"/300mm	70mm	5706915076332	25	5	30.25	36.30	



10507632

### WATER PUMP PLIERS

IRWIN® VISE-GRIP® Universal Water Pump pliers feature an all-purpose jaw, specially engineered to grip round, hex, square and flat surfaces. They are available with ProTouch™ grips (PTG) or thin grips (TG).

#### UNIVERSAL WATER PUMP PLIERS WITH PROTOUCH™ GRIP

ITEM NO.	DESCRIPTION	JAW CAPACITY	EAN	MASTER PACK	SHELF PACK	LP Ex VAT £ / ITEM	RRP Inc VAT £ / ITEM	DISC CODE
10507634	Universal Water Pump Pliers PTG 6"/150mm	29mm	5706915076349	25	5	17.59	21.11	IR (HT)
10507635	Universal Water Pump Pliers PTG 8"/200mm	45mm	5706915076356	25	5	18.82	22.58	
10507636	Universal Water Pump Pliers PTG 10"/250mm	57mm	5706915076363	25	5	21.98	26.38	
10507637	Universal Water Pump Pliers PTG 12"/300mm	70mm	5706915076370	25	5	27.23	32.68	

#### UNIVERSAL WATER PUMP PLIERS WITH THIN GRIP

ITEM NO.	DESCRIPTION	JAW CAPACITY	EAN	MASTER PACK	SHELF PACK	LP Ex VAT £ / ITEM	RRP Inc VAT £ / ITEM	DISC CODE
10507638	Universal Water Pump Pliers TG 6"/150mm	29mm	5706915076387	25	5	17.59	21.11	IR (HT)
10507639	Universal Water Pump Pliers TG 8"/200mm	45mm	5706915076394	25	5	18.82	22.58	
10507640	Universal Water Pump Pliers TG 10"/250mm	57mm	5706915076400	25	5	21.98	26.38	
10507641	Universal Water Pump Pliers TG 12"/300mm	70mm	5706915076417	25	5	27.23	32.68	

### GROOVE JOINT PLIERS

IRWIN® VISE-GRIP® Groove Joint pliers feature right angle teeth which grip in all directions for maximum bite. They all have moulded ProTouch™ grips for added comfort and less hand fatigue.

#### GROOVE JOINT PLIERS WITH PROTOUCH™ GRIPS

ITEM NO.	DESCRIPTION	JAW CAPACITY	EAN	MASTER PACK	SHELF PACK	LP Ex VAT £ / ITEM	RRP Inc VAT £ / ITEM	DISC CODE
10505498	Groove Joint Plier 8"/200mm	38mm	5706915054989	25	5	10.15	12.18	IR (HT)
10505500	Groove Joint Plier 10"/250mm	51mm	5706915055009	25	5	11.61	13.93	
10505502	Groove Joint Plier 12"/300mm	57mm	5706915055023	25	5	13.07	15.68	

# PLIERS & WRENCHES



## WISE-GRIP® PLIERS

IRWIN® VISE-GRIP® pliers set the standard for dependability, quality and innovation. Wherever there's a need for a quality plier, IRWIN® VISE-GRIP® is on the job. IRWIN® VISE-GRIP® offers a full line of pliers including traditional pliers, cutting pliers and specialty tools.

INDUCTION HARDENED CUTTING EDGES

POWER SLOT TECHNOLOGY

THREE-ZONE COMFORT GRIPS



INTEGRATED HANDLE HOOKS

SPECIAL ANTI-RUST COATING

### PERFORMANCE CUTTING PLIERS

The new IRWIN® VISE-GRIP® Cutting Pliers, made in Germany, are constructed of high-quality steel and specially coated for superior rust-resistance and longer tool life.

The induction-hardened cutting edges are durable enough to cut Aluminium-conductor steel-reinforced cable (ACSR), nails, screws, and even piano wire without damaging the cutting edge. Industry-leading, three-zone comfort grips are contoured for optimal cushion and control, allowing the user to make more cuts comfortably.



POWER SLOT

2X THE POWER.

HALF THE EFFORT.



1950504

1950508

62° ERGONOMIC ANGLED HEAD

62° ANGLED HEAD  
REDUCES WRIST STRAIN

- POWER SLOT TECHNOLOGY**  
Provides 2X more power and half the cutting effort\*
- INDUCTION-HARDENED CUTTING EDGES**  
Cut Aluminium-conductor steel-reinforced (ACSR) cable, nails, screws and even piano wire
- THREE-ZONE COMFORT GRIPS**  
Contoured for optimal cushion and control
- SPECIAL ANTI-RUST COATING**  
For superior rust-resistance and longer tool life
- INTEGRATED HANDLE HOOKS**  
Compatible with IRWIN® Performance Lanyard system for safer elevated working conditions and easier retrieval when stored
- 62° ERGONOMIC ANGLED HEAD**  
For reduced wrist strain

PowerSlot is available in 7" and 8" diagonal cutting pliers and 8" end cutting pliers

\*Average cutting performance of PowerSlot pliers in 14/2 Romex® wire vs. standard IRWIN® Pliers of same type.

	ITEM NO.	DESCRIPTION	JOINT DESIGN	CUTTING CAPACITY	EAN	MASTER PACK	SHELF PACK	LP Ex VAT £ / ITEM	RRP Inc VAT £ / ITEM	DISC CODE
1950504	1950502	6" High Leverage Diagonal Cutting Pliers	Fixed	2 mm HW	5706919505029	10	1	28.89	34.67	IR (HT)
	1950503	7" Max Leverage Diagonal Cutting Pliers with Powerslot	PowerSlot	3 mm HW	5706919505036	10	1	35.38	42.46	
1950507	1950504	8" Max Leverage Diagonal Cutting Pliers with Powerslot	PowerSlot	3 mm HW	5706919505043	10	1	43.91	52.69	
	1950506	6" Standard Long Nose Pliers	Fixed	2 mm HW	5706919505067	10	1	26.49	31.79	
	1950507	8" Standard Long Nose Pliers	Fixed	2 mm HW	5706919505074	10	1	32.04	38.45	
	1950508	8" Ergomulti Long Nose Pliers with Wire Stripper & Crimper	Fixed	2 mm HW	5706919505081	10	1	44.76	53.71	
	1950509	6-3/4" Bent Nose Pliers	Fixed	2 mm HW	5706919505098	10	1	29.06	34.87	
	1950510	8" Max Leverage End Cutting Pliers with Powerslot	PowerSlot	3 mm HW	5706919505104	10	1	42.80	51.36	
	1950511	Performance Lanyard System with Clip	-	-	5706919505111	10	1	8.72	10.46	

HW = Hard Wire

## TRADITIONAL PLIERS

IRWIN® VISE-GRIP® traditional pliers have induction hardened cutting edges which stay sharp longer. The pliers also feature machined jaws for maximum gripping strength and moulded ProTouch™ grips for added comfort and less hand fatigue. TÜV/GS approvals demonstrate the high manufacturing standards of these VISE-GRIP® tools.



## COMBINATION PLIERS



- 1. MULTI-GRIP JAWS**  
With maximum gripping groove design
- 2. PROTOUCH™ GRIPS**  
Are moulded for comfort and provide less hand fatigue
- 3. INDUCTION HARDENED CUTTING FACE**  
To stay sharper, longer
- 4. CABLE CUTTER**  
Up to Ø 1,6mm cables
- 5. CHROMIUM NICKEL STEEL**  
For improved durability on the gripping and cutting face

ITEM NO.	DESCRIPTION	EAN	MASTER PACK	SHELF PACK	LP Ex VAT £ / ITEM	RRP Inc VAT £ / ITEM	DISC CODE
10505875	Combination Plier 6"/150mm	5706915058758	25	5	13.07	15.68	IR (HT)
1910231	Combination Plier 7"/175mm	5706915058772	25	5	14.51	17.41	
10505876	Combination Plier 8"/200mm	5706915058765	25	5	15.98	19.18	



10505876

## DIAGONAL CUTTING PLIERS

Induction hardened cutting edges designed to stay sharper longer for wire cutting.

ITEM NO.	DESCRIPTION	EAN	MASTER PACK	SHELF PACK	LP Ex VAT £ / ITEM	RRP Inc VAT £ / ITEM	DISC CODE
10505493	Diagonal Cutting Pliers 6"/150mm	5706915054934	25	5	10.15	12.18	IR (HT)
10505494	Diagonal Cutting Pliers 7"/175mm	5706915054941	25	5	11.61	13.93	
10505495	Diagonal Cutting Pliers 8"/200mm	5706915054958	25	5	13.07	15.68	



10505495

## END CUTTING PLIERS

Throat clearance allows semi-flush cutting of nails and rivets.

ITEM NO.	DESCRIPTION	EAN	MASTER PACK	SHELF PACK	LP Ex VAT £ / ITEM	RRP Inc VAT £ / ITEM	DISC CODE
10505517	End Cutting Pliers 8"/200mm	5706915055177	25	5	14.51	17.41	IR (HT)



10505517

## CABLE CUTTER

Cuts copper and aluminium wire.

ITEM NO.	DESCRIPTION	EAN	MASTER PACK	SHELF PACK	LP Ex VAT £ / ITEM	RRP Inc VAT £ / ITEM	DISC CODE
10505518	Cable Cutter 8"/200mm	5706915055184	25	5	14.51	17.41	IR (HT)



10505518



### LONG NOSE PLIERS

Thin nose profile gets into tight spaces and is easier to reach around obstructions.



10505504

ITEM NO.	DESCRIPTION	EAN	MASTER PACK	SHELF PACK	LP Ex VAT £ / ITEM	RRP Inc VAT £ / ITEM	DISC CODE
10505503	Long Nose Pliers 6"/150mm	5706915055030	25	5	10.15	12.18	IR (HT)
10505504	Long Nose Pliers 8"/200mm	5706915055047	25	5	11.61	13.93	IR (HT)

### BENT NOSE PLIERS

Thin, angled nose profile gets into tight spaces and is easier to reach around obstructions.



10505506

ITEM NO.	DESCRIPTION	EAN	MASTER PACK	SHELF PACK	LP Ex VAT £ / ITEM	RRP Inc VAT £ / ITEM	DISC CODE
10505505	Bent Nose Pliers 6"/150mm	5706915055054	25	5	10.15	12.18	IR (HT)
10505506	Bent Nose Pliers 8"/200mm	5706915055061	25	5	11.61	13.93	IR (HT)

### NIPPER PLIERS

Throat clearance allows for semi-flush cutting.



10508151

ITEM NO.	DESCRIPTION	EAN	MASTER PACK	SHELF PACK	LP Ex VAT £ / ITEM	RRP Inc VAT £ / ITEM	DISC CODE
10508153	Nipper Plier TG 6"/150mm	5706915081534	25	5	9.30	11.16	IR (HT)
10508152	Nipper Plier TG 7"/175mm	5706915081527	25	5	10.44	12.53	IR (HT)
10508151	Nipper Plier TG 8"/200mm	5706915081534	25	5	12.06	14.47	IR (HT)

### CONSTRUCTION NIPPERS

Precision-machined jaws and induction hardened cutting edge provide a clean cut.



10508154

ITEM NO.	DESCRIPTION	EAN	MASTER PACK	SHELF PACK	LP Ex VAT £ / ITEM	RRP Inc VAT £ / ITEM	DISC CODE
10508154	Construction Nippers TG 9"/225mm	5706915081541	25	5	13.60	16.32	IR (HT)

### NAIL PULLERS

Machined jaws provide maximum gripping strength.



10508157

ITEM NO.	DESCRIPTION	EAN	MASTER PACK	SHELF PACK	LP Ex VAT £ / ITEM	RRP Inc VAT £ / ITEM	DISC CODE
10508156	Nail Puller TG 10"/250mm	5706915081565	25	5	14.24	17.09	IR (HT)
10508157	Nail Puller TG 8"/200mm	5706915081572	25	5	12.39	14.87	IR (HT)

### TRADITIONAL PLIER SET



10505483

ITEM NO.	DESCRIPTION	EAN	MASTER PACK	SHELF PACK	LP Ex VAT £ / ITEM	RRP Inc VAT £ / ITEM	DISC CODE
10505483	ProPliers 3pcs Set (6"/150mm Diagonal Cutter, 8"/200mm Long Nose Plier, 7"/175mm Combination Plier)	5706915054835	5	5	36.26	43.51	IR (HT)

# PLIERS & WRENCHES

## ADJUSTABLE WRENCHES

IRWIN® VISE-GRIP® wrenches have scales in metric and imperial, and are available with ProTouch™ Grip for added comfort. TUV/GS approvals demonstrate the high manufacturing standards of the VISE-GRIP® sub-brand. Parallel jaws with smooth surfaces assist a secure grip and help prevent scratches.

### ADJUSTABLE WRENCH WITH PROTOUCH GRIP

ITEM NO.	DESCRIPTION	CAPACITY	EAN	MASTER PACK	SHELF PACK	LP Ex VAT £ / ITEM	RRP Inc VAT £ / ITEM	VAT	DISC CODE
10505486	Adjustable Wrench PTG 6"/150mm	1"/25mm	5706915054866	25	5	10.15	12.18		IR (HT)
10505488	Adjustable Wrench PTG 8"/200mm	1-1/8" / 28mm	5706915054880	25	5	11.61	13.93		
10505490	Adjustable Wrench PTG 10"/250mm	1-1/4" / 31mm	5706915054903	25	5	13.81	16.57		
10505492	Adjustable Wrench PTG 12"/300mm	1-1/2" / 38mm	5706915054927	20	5	17.44	20.93		



10505492

### ADJUSTABLE WRENCH WITH STEEL HANDLE

ITEM NO.	DESCRIPTION	CAPACITY	EAN	MASTER PACK	SHELF PACK	LP Ex VAT £ / ITEM	RRP Inc VAT £ / ITEM	VAT	DISC CODE
10508161	Adjustable Wrench Steel Handle 6"/150mm	1" / 25mm	5706915081619	20	5	10.15	12.18		IR (HT)
10508160	Adjustable Wrench Steel Handle 8"/200mm	1-1/8" / 28mm	5706915081602	20	5	11.61	13.93		
10508159	Adjustable Wrench Steel Handle 10"/250mm	1-1/4" / 31mm	5706915081596	20	5	13.81	16.57		
10508158	Adjustable Wrench Steel Handle 12"/300mm	1-1/2" / 38mm	5706915081589	20	5	17.44	20.93		



10508160





### VDE PLIERS

CROSS-HATCHED  
JAWS

CABLE CUTTER

INDUCTION HARDENED  
CUTTING FACE

PROTOUCH™ GRIPS

#### VDE COMBINATION PLIERS

IRWIN® Wise-Grip® VDE Pliers are fully TÜV, GS and VDE certified, meaning they are guaranteed safe for working with electrical equipment up to AC 1000V or DC 1500V. Their induction hardened cutting edges stay sharp longer, and their machined jaws are designed for maximum gripping strength. Plus, their ProTouch™ grips provide extra comfort for less hand fatigue.



**1. CROSS-HATCHED JAWS**

Maximum gripping

**2. PROTOUCH™ GRIPS**

For comfort and reduced hand fatigue

**3. INDUCTION HARDENED CUTTING FACE**

Stays sharper longer

**4. CABLE CUTTER**

Up to Ø 1.6mm cables

**5. CHROMIUM NICKEL STEEL**

For improved durability on the gripping and cutting face



10505874

ITEM NO.	DESCRIPTION	EAN	MASTER PACK	SHELF PACK	LP Ex VAT £ / ITEM	RRP Inc VAT £ / ITEM	DISC CODE
10505872	VDE Combination Pliers 6"/150mm	5706915058727	25	5	18.38	22.06	IR (HT)
10505873	VDE Combination Pliers 7"/175mm	5706915058734	25	5	19.80	23.76	
10505874	VDE Combination Pliers 8"/200mm	5706915058741	25	5	21.23	25.48	

#### VDE LONG AND BENT NOSE PLIERS

Thin nose profile gets into tight spaces, easy to reach around obstructions.



10505869

ITEM NO.	DESCRIPTION	EAN	MASTER PACK	SHELF PACK	LP Ex VAT £ / ITEM	RRP Inc VAT £ / ITEM	DISC CODE
10505868	VDE Long Nose Pliers 6"/150mm	5706915058680	25	5	18.38	22.06	IR (HT)
10505869	VDE Long Nose Pliers 8"/200mm	5706915058697	25	5	21.23	25.48	
10505870	VDE Bent Nose Pliers 8"/200mm	5706915058703	25	5	21.23	25.48	



10505870

## VDE DIAGONAL CUTTING PLIERS

Induction hardened cutting edges designed to stay sharper longer for wire cutting.

ITEM NO.	DESCRIPTION	EAN	MASTER PACK	SHELF PACK	LP Ex VAT £ / ITEM	RRP Inc VAT £ / ITEM	DISC CODE
10505865	VDE Diagonal Cutting Pliers 6"/150mm	5706915058659	25	5	18.38	22.06	IR (HT)
10505866	VDE Diagonal Cutting Pliers 7"/175mm	5706915058666	25	5	19.80	23.76	
10505867	VDE Diagonal Cutting Pliers 8"/200mm	5706915058673	25	5	21.23	25.48	



10505865

## VDE WIRE STRIPPER

V-shape Cutters provide easy and precise wire stripping up to Ø 1,6 mm cables.

ITEM NO.	DESCRIPTION	EAN	MASTER PACK	SHELF PACK	LP Ex VAT £ / ITEM	RRP Inc VAT £ / ITEM	DISC CODE
10505871	VDE Wire Strippers 6"/150mm	5706915058710	25	5	19.80	23.76	IR (HT)



10505871

## VDE PLIERS SET

ITEM NO.	DESCRIPTION	EAN	MASTER PACK	SHELF PACK	LP Ex VAT £ / ITEM	RRP Inc VAT £ / ITEM	DISC CODE
10505519	3pcs Set (6"/150mm diagonal cutter, 8"/200mm long nose plier, 7"/175mm combination plier)	5706915055191	5	5	59.37	71.24	IR (HT)



10505519



## WHAT IS VDE

▪ SAFELY WORKING WITH ELECTRICAL EQUIPMENT UP TO AC OR CD1500VOLT



**IRWIN®**

*Record®*



## PIPE WRENCHES

IRWIN® Record® offer a full range of plumbing tools designed to get the job done quickly and efficiently. From our solid-forged Stillson Wrenches to the lightweight Quick-Adjusting Wrench, our range of pipe tools offer superior grip due to the unique 'V-shaped' tooth profile.

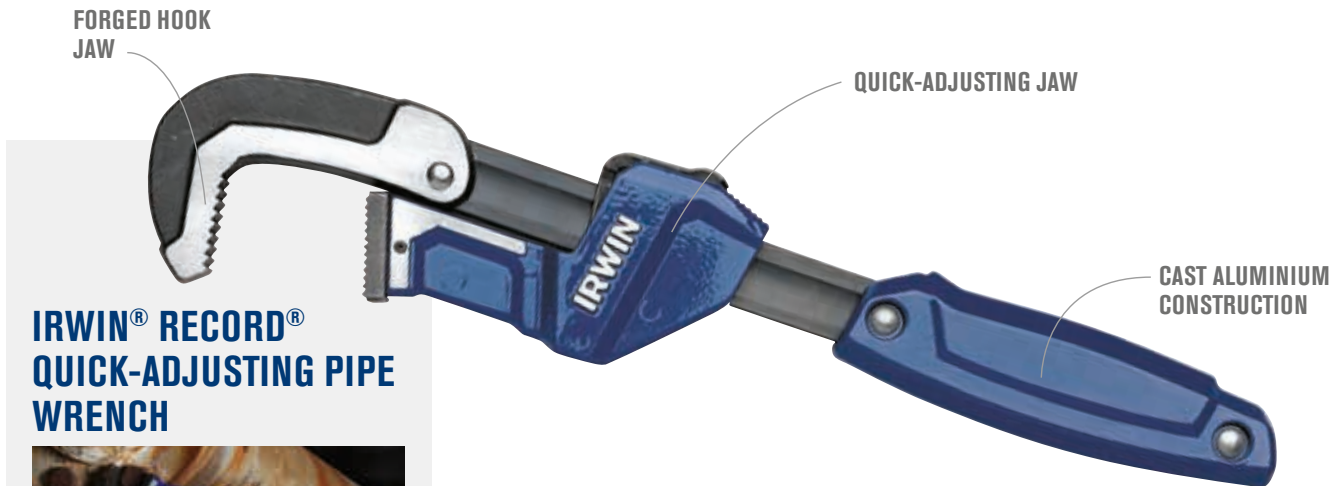

### IRWIN® RECORD® QUICK-ADJUSTING PIPE WRENCH



#### 1. FORGED HOOK JAW

With 2-1/4" (58mm) jaw capacity equivalent to standard 14" (350mm) pipe wrench; ideal for pipe diameters up to 1-1/2" (38mm); ideal for most surfaces including black, galvanized, PVC and copper pipe, as well as nuts, bolts and couplings; broached teeth

#### 2. QUICK-ADJUSTING JAW

With one-handed operation, ratchets quickly to work the surface

#### 3. CAST ALUMINIUM CONSTRUCTION

40% less weight than standard 14" (350mm) cast iron pipe wrench; ergonomic handle is ideal for heavy torque and maximum comfort

**3X** FASTER\*

ITEM NO.	DESCRIPTION	CAPACITY	EAN	MASTER PACK	SHELF PACK	LP Ex VAT £ / ITEM	RRP Inc VAT £ / ITEM	DISC CODE
10503642	Quick-Adjusting Wrench	3 - 58mm	5706915036428	-	5	32.43	38.92	IR (HT)



### STILLSON PIPE WRENCHES

Solid forged handle and jaw with One Piece Unbreakable (S.G.) iron.

ITEM NO.	DESCRIPTION	CAPACITY	EAN	MASTER PACK	SHELF PACK	LP Ex VAT £ / ITEM	RRP Inc VAT £ / ITEM	DISC CODE
T3008	Stillson Wrench 8"/200mm	3/4" / 19mm	0734442111122	-	6	28.18	33.82	RI
T30010	Stillson Wrench 10"/250mm	1" / 25mm	0734442111368	-	6	31.98	38.38	
T30012	Stillson Wrench 12"/300mm	1-1/4" / 32mm	0734442111603	-	6	39.23	47.08	
T30014	Stillson Wrench 14"/350mm	1-1/2" / 38mm	0734442111849	-	6	42.87	51.44	
T30018	Stillson Wrench 18"/450mm	2" / 51mm	0734442111962	-	6	62.29	74.75	
T30024	Stillson Wrench 24"/600mm	2-1/2" / 63mm	0734442112082	-	6	118.71	142.45	
T30036	Stillson Wrench 36"/900mm	3-1/2" / 89mm	0734442112204	-	6	246.75	296.10	



### STILLSON WRENCHES SPARE PARTS

ITEM NO.	DESCRIPTION	EAN	MASTER PACK	SHELF PACK	LP Ex VAT £ / ITEM	RRP Inc VAT £ / ITEM	DISC CODE
T30018A	Jaw Complete with Nut (F)	0734442120605	1	4	47.94	57.53	IR (HT)
T30036A	Jaw Complete with Nut (F)	0734442121800	1	4	103.09	123.71	
T30018C	Frame with Pin (D) & Coil Spring (E)	0734442120841	1	4	24.78	29.74	
T30036C	Frame with Pin (D) & Coil Spring (E)	0734442122043	1	4	65.90	79.08	
T30024F	Nut (New Thread)	0734442117728	1	4	13.69	16.43	
T30036F	Nut	0734442119883	1	1	15.94	19.13	

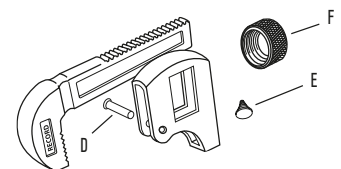

\* Than traditional pipe wrenches

### LEADER PIPE WRENCHES

Heavy-duty frame and handle are a one-piece ductile iron casting guaranteed against breakage.



T3508

ITEM NO.	DESCRIPTION	CAPACITY	EAN	MASTER PACK	SHELF PACK	LP Ex VAT £ / ITEM	RRP Inc VAT £ / ITEM	DISC CODE
T3508	Leader Wrench 8"/200mm	1" (25mm)	0734442112440	-	4	24.22	29.06	RI
T35010	Leader Wrench 10"/250mm	1-1/2" (38mm)	0734442112563	-	4	30.15	36.18	
T35012	Leader Wrench 12"/300mm	2" (51mm)	0734442112327	-	4	32.64	39.17	
T35014	Leader Wrench 14"/350mm	2" (51mm)	0734442112686	-	4	81.16	97.39	
T35018	Leader Wrench 18"/450mm	2-1/2" (63mm)	0734442112808	-	4	109.61	131.53	
T35024	Leader Wrench 24"/600mm	3" (76mm)	0734442112921	-	1	148.14	177.77	
T35036	Leader Wrench 36"/900mm	5" (127mm)	0734442113041	-	1	307.29	368.75	
T35048	Leader Wrench 48"/1220mm	6" (152mm)	0734442113065	-	1	489.87	587.84	

### LEADER WRENCHES SPARE PARTS

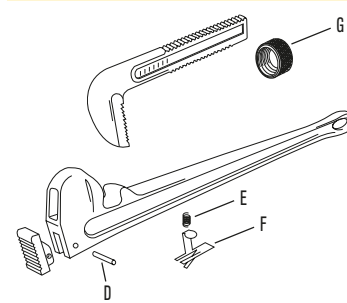

ITEM NO.	DESCRIPTION	EAN	MASTER PACK	SHELF PACK	LP Ex VAT £ / ITEM	RRP Inc VAT £ / ITEM	DISC CODE
T35018A	Hook Jaw c/w Nut (G)	0734442125280	1	4	55.00	66.00	IR (HT)
T35024A	Hook Jaw c/w Nut (G)	0734442126126	1	4	89.87	107.84	
T35036A	Hook Jaw c/w Nut (G)	0734442126966	1	4	174.55	209.46	
T35048A	Hook Jaw c/w Nut (G)	0734442127802	1	4	315.94	379.13	
T35010C	Handle Jaw with Pin (D)	0734442123842	1	4	7.89	9.47	
T35018C	Handle Jaw with Pin (D)	0734442125402	1	1	35.16	42.19	
T35024C	Handle Jaw with Pin (D)	0734442126249	1	1	36.23	43.48	
T35048C	Handle Jaw with Pin (D)	0734442127925	1	1	58.69	70.43	
T35010E	Coil Spring (E) & Flat Spring (F)	0734442124085	1	1	4.75	5.70	

### HANDIWRENCH

Chain pipe wrenches are mainly used in confined spaces, such as against a wall or close to a nest of other piping. Simply loop the chain around the pipe, lock it and the jaws will grip in the direction of the turn. The pipe can then be easily tightened or loosened with short strokes of the handle.



ITEM NO.	DESCRIPTION	CAPACITY	EAN	MASTER PACK	SHELF PACK	LP Ex VAT £ / ITEM	RRP Inc VAT £ / ITEM	DISC CODE
T240	Handi-wrench Ø100	4" (101mm)	0734442113522	48	4	45.12	54.14	RI

### CHAIN PIPE WRENCHES



T235C

ITEM NO.	DESCRIPTION	CAPACITY	EAN	MASTER PACK	SHELF PACK	LP Ex VAT £ / ITEM	RRP Inc VAT £ / ITEM	DISC CODE
T23112	Chain Pipe Wrench Ø61mm/14"	5/16" - 2" / 8-51mm	0734442109082	12	1	139.77	167.72	RI
T23212	Chain Pipe Wrench Ø90mm/21-1/2"	5/16" - 3" / 8-76mm	0734442109204	12	1	231.12	277.34	
T233C	Chain Pipe Wrench Ø115mm/36"	1/2" - 4" / 13-101mm	0734442113164	6	1	320.80	384.96	
T234C	Chain Pipe Wrench Ø220mm/51"	1" - 8" / 25-203mm	0734442113287	6	1	622.14	746.57	
T235C	Chain Pipe Wrench 64-1/2"	2" - 12" / 50 - 300mm	0734442114000	6	1	870.91	1045.09	

### CHAIN PIPE WRENCHES REPLACEMENT CHAINS

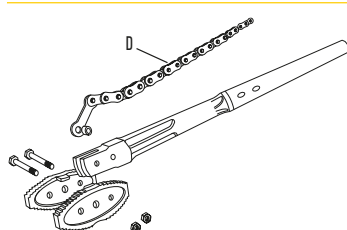

ITEM NO.	DESCRIPTION	EAN	MASTER PACK	SHELF PACK	LP Ex VAT £ / ITEM	RRP Inc VAT £ / ITEM	DISC CODE
T233CDB	Chain with Bush (D)	0734442113881	1	1	58.41	70.09	IR (HT)
T234CDB	Chain with Bush (D)	0734442114246	1	1	142.92	171.50	